

# Goulotte de câblage SES® avec fentes latérales et perforations du fond



GF-DIN-A7/5  
GF-DIN-A6/4



## GF-DIN-A7/5 -A6/4

**Matière :** PVC rigide qualité 9051 LF  
**Coloris :** gris RAL7030 - noir  
**Température d'utilisation :** -5 à +65°C  
**Densité :** 1,56  
**Résistivité transversale :** 10<sup>15</sup> Ω.cm  
**Rigidité diélectrique :** 15kV/mm  
**Spécification :** UL94-V0  
**Longueur standard :** 2 mètres  
**Ruban double face :** sur demande  
**Minimum livrable :** 1 emballage complet (couvercles inclus)

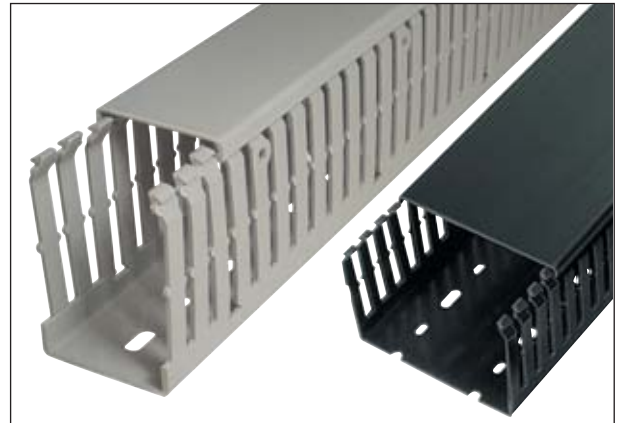



Exemple de commande :

Coloris : 013 gris 010 noir

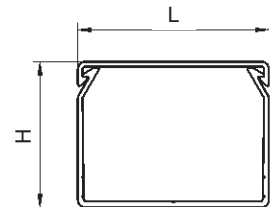
code groupe	détail article	code coloris
0845	xxxxxx	xxx



type	goulottes code article	 m	dimensions ext.		nombre de fils par goulotte (remplissage 50 %)			couvercles (seuls) code article		 m
			H mm	L mm	1 mm <sup>2</sup>	1,5 mm <sup>2</sup>	2,5 mm <sup>2</sup>	code article	m	
<b>GF-DIN-A7/5 25 x 25</b>	0845 0031 ***	48	23	23	25	21	17	0845 0640 ***	48	
<b>GF-DIN-A7/5 37,5x 25</b>	0845 0041 ***	48	35,5	23	44	36	30	0845 0640 ***	48	
<b>GF-DIN-A7/5 37,5x 37,5</b>	0845 0051 ***	24	35,5	35,5	74	61	51	0845 0645 ***	24	
<b>GF-DIN-A7/5 37,5x 50</b>	0845 0061 ***	24	35,5	48	105	86	72	0845 0650 ***	24	
<b>GF-DIN-A7/5 50 x 25</b>	0845 0131 ***	48	48	23	62	51	42	0845 0640 ***	48	
<b>GF-DIN-A7/5 50 x 37,5</b>	0845 0141 ***	24	48	35,5	104	85	71	0845 0645 ***	24	
<b>GF-DIN-A7/5 50 x 50</b>	0845 0151 ***	24	48	48	146	120	100	0845 0650 ***	24	
<b>GF-DIN-A7/5 50 x 75</b>	0845 0152 ***	24	48	73	230	189	158	0845 0655 ***	24	
<b>GF-DIN-A7/5 50 x 100</b>	0845 0153 ***	12	48	98	315	259	216	0845 0630 ***	12	
<b>GF-DIN-A7/5 50 x 125</b>	0845 0154 ***	12	48	123	399	328	274	0845 0665 ***	12	
<b>GF-DIN-A7/5 75 x 25</b>	0845 0211 ***	48	73	25	101	83	69	0845 0640 ***	48	
<b>GF-DIN-A7/5 75 x 37,5</b>	0845 0221 ***	24	73	35,5	161	132	111	0845 0645 ***	24	
<b>GF-DIN-A7/5 75 x 50</b>	0845 0231 ***	24	73	48	227	186	156	0845 0650 ***	24	
<b>GF-DIN-A7/5 75 x 75</b>	0845 0241 ***	24	73	73	358	294	246	0845 0655 ***	24	
<b>GF-DIN-A7/5 75 x 100</b>	0845 0251 ***	12	73	98	489	402	336	0845 0630 ***	12	
<b>GF-DIN-A7/5 75 x 125</b>	0845 0261 ***	12	73	123	620	509	426	0845 0665 ***	12	
<b>GF-DIN-A6/4 100 x 50</b>	0845 0286 013	24	100	48	304	250	209	0845 0650 013	24	
<b>GF-DIN-A6/4 100 x 75</b>	0845 0296 013	12	100	73	484	398	333	0845 0655 013	24	

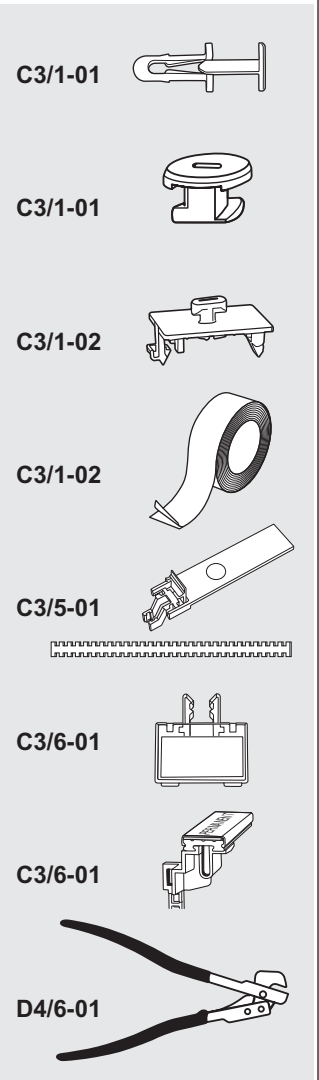

**Goulotte de câblage SES®**  
avec fentes latérales et perforations du fond



**GF-DIN-A7/5**  
**GF-DIN-A6/4**



**GF-DIN-A7/5**

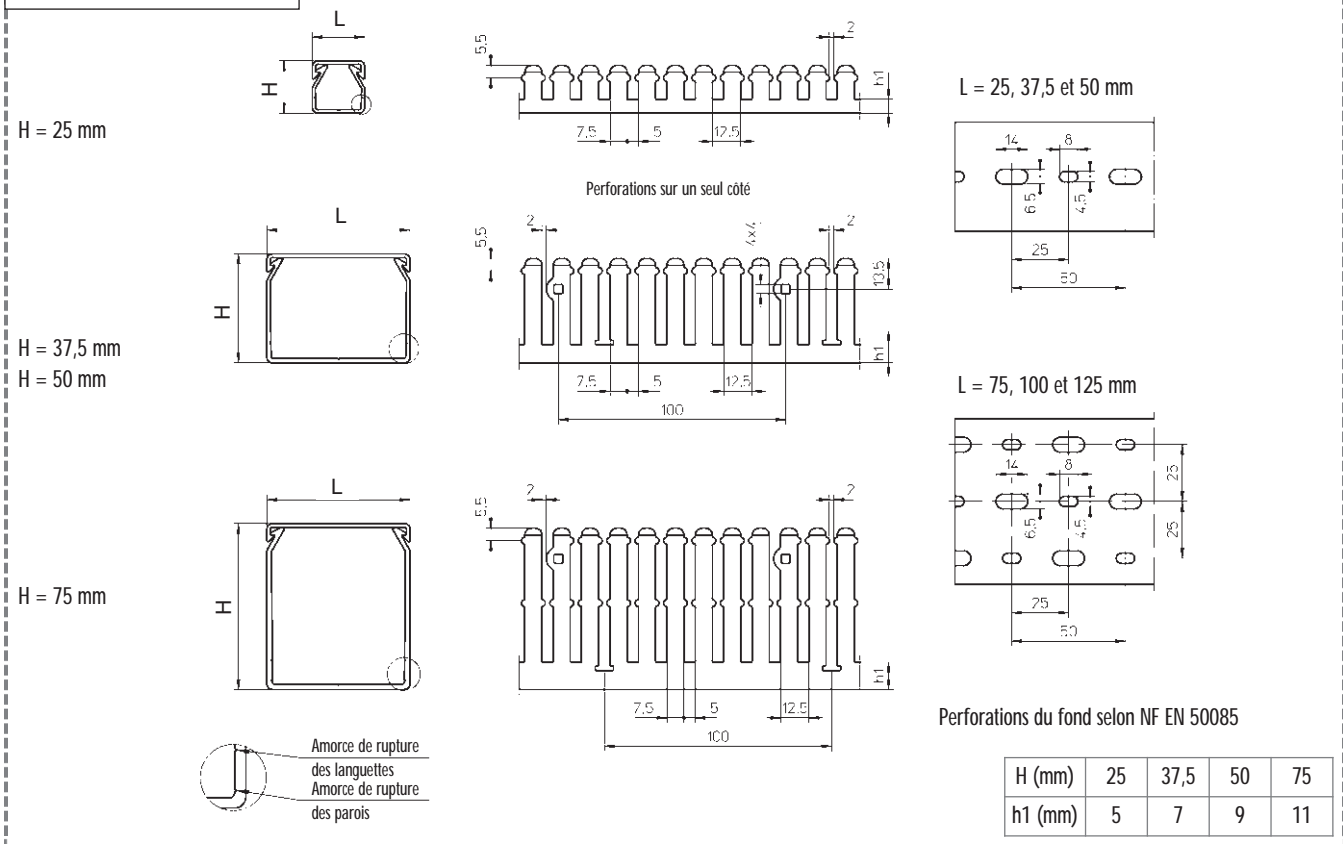

**GF-DIN-A6/4**

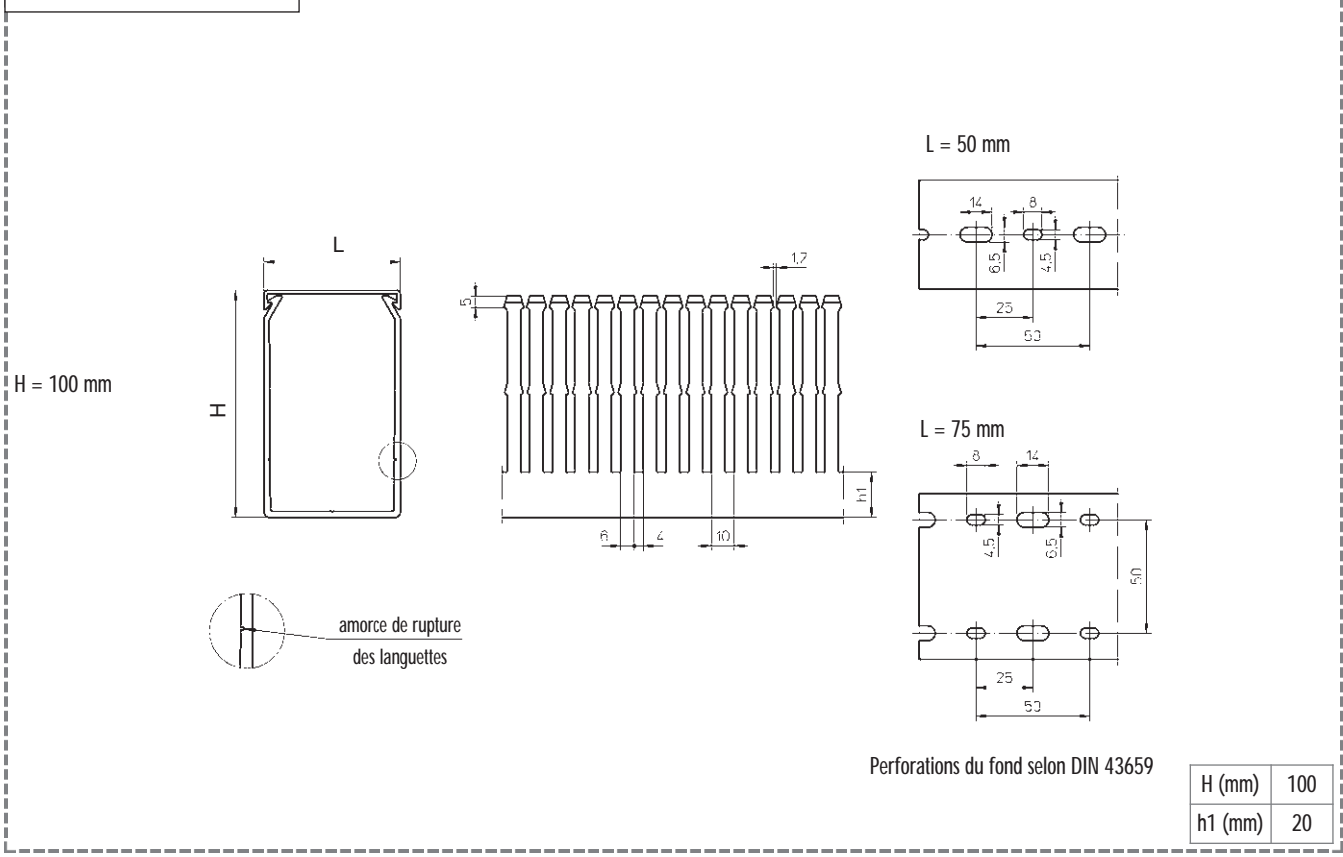

# Goulotte de câblage SES® sans halogène avec fentes latérales et perforations du fond





GF-DIN-SH-A7/5



## GF-DIN-SH-A7/5

**Matière :** Polyphénylène éther modifié (PPE/PS)  
**Coloris :** gris clair RAL7035  
**Température d'utilisation :** -25 à +70°C  
**Densité :** 1,10  
**Résistivité transversale :** 10<sup>15</sup> Ω.cm  
**Rigidité diélectrique :** 16 kV/mm  
**Spécification :** UL94-V1  
**Recommandations :** Pas de contact avec des huiles ou des graisses  
**Longueur standard :** 2 mètres  
**Ruban double face :** sur demande  
**Minimum livrable :** 1 emballage complet (couvercles inclus)



type	goulottes code article	 m	dimensions ext.		nombre de fils par goulotte (remplissage 50 %)			couvercles (seuls) code article		 m
			H mm	L mm	1 mm <sup>2</sup>	1,5 mm <sup>2</sup>	2,5 mm <sup>2</sup>			
GF-DIN-SH-A7/5 37,5x 37,5	0848 0051 013	24	35,5	35,5	74	61	51	0848 0645 013	12	
GF-DIN-SH-A7/5 50 x 37,5	0848 0141 013	24	48	35,5	104	85	71	0848 0645 013	12	
GF-DIN-SH-A7/5 50 x 50	0848 0151 013	24	48	48	146	120	100	0848 0650 013	12	
GF-DIN-SH-A7/5 50 x 75	0848 0152 013	24	48	73	230	189	158	0848 0655 013	12	
GF-DIN-SH-A7/5 50 x 100	0848 0153 013	12	48	98	315	259	216	0848 0660 013	12	
GF-DIN-SH-A7/5 75 x 37,5	0848 0221 013	24	73	35,5	161	132	111	0848 0645 013	12	
GF-DIN-SH-A7/5 75 x 50	0848 0231 013	24	73	48	227	186	156	0848 0650 013	12	
GF-DIN-SH-A7/5 75 x 75	0848 0241 013	24	73	73	358	294	246	0848 0655 013	12	
GF-DIN-SH-A7/5 75 x 100	0848 0251 013	12	73	98	489	402	336	0848 0660 013	12	
GF-DIN-SH-A7/5 75 x 125	0848 0261 013	12	73	123	620	509	426	0848 0665 013	12	

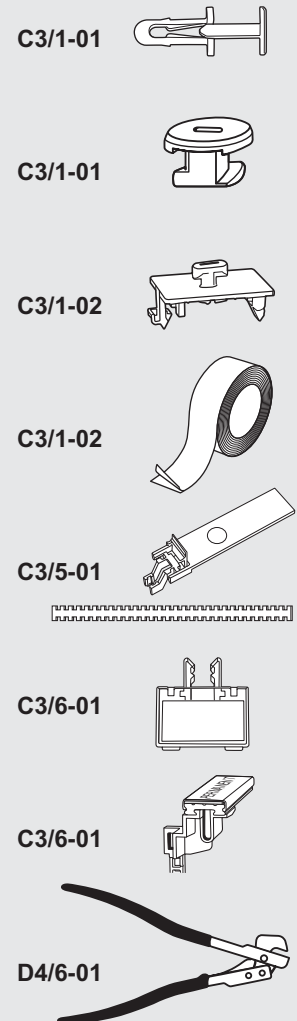
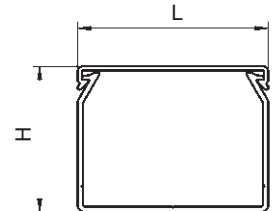

**Goulotte de câblage SES®**  
avec fentes latérales et perforations du fond



**GF-DIN-SH**



**GF-DIN-SH-A7/5**

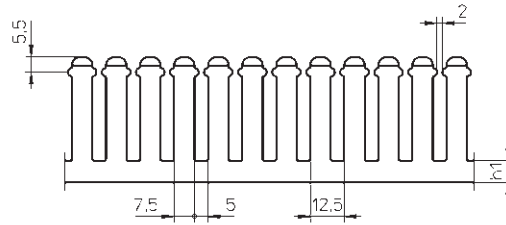
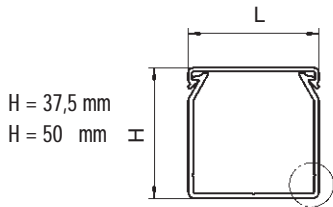

L = 37,5 et 50 mm

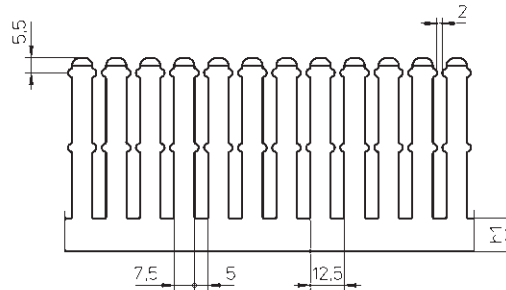
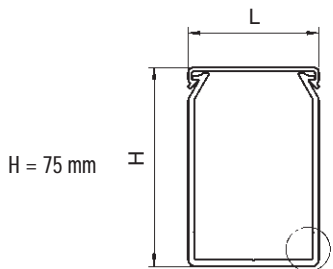
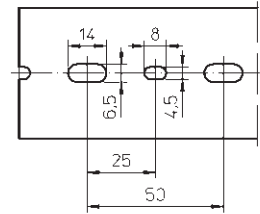

L = 75, 100 et 125 mm

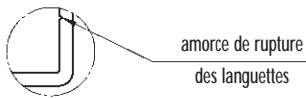
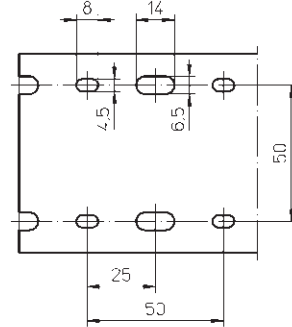

Perforations du fond selon DIN 43659

H (mm)	37,5	50	75
h1 (mm)	8	8	12

# Goulotte de câblage SES® avec fentes latérales et perforations du fond



GF-DIN-C-A12/8



## GF-DIN-C-A12/8

**Matière :** PVC rigide qualité 9051 LF  
**Coloris :** gris RAL7030 - noir  
**Température d'utilisation :** -5 à +65°C  
**Densité :** 1,56  
**Résistivité transversale :** 10<sup>15</sup> Ω.cm  
**Rigidité diélectrique :** 15 kV/mm  
**Spécifications :** UL94-V0  
**Longueur standard :** 2 mètres  
**Ruban double face :** sur demande  
**Minimum livrable :** 1 emballage complet (couvertres inclus)

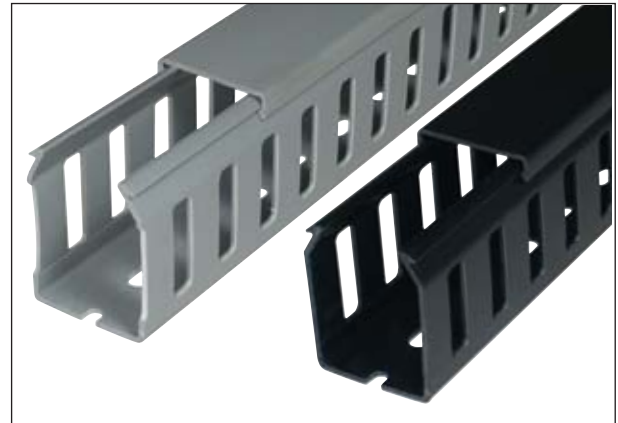



Exemple de commande :

Coloris : 013 gris 010 noir

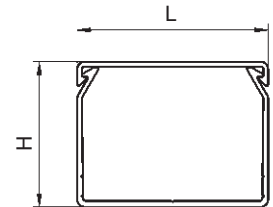
code groupe	détail article	code coloris
0845	xxxxxx	xxxx



type	goulottes code article	 m	dimensions ext.		nombre de fils par goulotte (remplissage 50 %)			couvertres (seuls) code article	 m	
			H mm	L mm	1 mm <sup>2</sup>	1,5 mm <sup>2</sup>	2,5 mm <sup>2</sup>			
GF-DIN-C-A12/8	37,5 x 25	0845 0046 ***	48	35,5	23	44	36	30	0845 0640 ***	48
GF-DIN-C-A12/8	37,5 x 37,5	0845 0056 ***	24	35,5	35,5	74	61	51	0845 0645 ***	24
GF-DIN-C-A12/8	37,5 x 50	0845 0066 ***	24	35,5	48	105	86	72	0845 0650 ***	24
GF-DIN-C-A12/8	50 x 25	0845 0136 ***	48	48	23	62	51	42	0845 0640 ***	48
GF-DIN-C-A12/8	50 x 37,5	0845 0146 ***	24	48	35,5	104	85	71	0845 0645 ***	24
GF-DIN-C-A12/8	50 x 50	0845 0166 ***	24	48	48	146	120	100	0845 0650 ***	24
GF-DIN-C-A12/8	50 x 75	0845 0167 ***	24	48	73	230	189	158	0845 0655 ***	24
GF-DIN-C-A12/8	50 x 100	0845 0168 ***	12	48	98	315	259	216	0845 0630 ***	12
GF-DIN-C-A12/8	50 x 125	0845 0169 ***	12	48	123	399	328	274	0845 0665 ***	12
GF-DIN-C-A12/8	75 x 25	0845 0216 ***	48	73	25	101	83	69	0845 0640 ***	48
GF-DIN-C-A12/8	75 x 37,5	0845 0226 ***	24	73	35,5	161	132	111	0845 0645 ***	24
GF-DIN-C-A12/8	75 x 50	0845 0236 ***	24	73	48	227	186	156	0845 0650 ***	24
GF-DIN-C-A12/8	75 x 75	0845 0246 ***	24	73	73	358	294	246	0845 0655 ***	24
GF-DIN-C-A12/8	75 x 100	0845 0256 ***	12	73	98	489	402	336	0845 0630 ***	12
GF-DIN-C-A12/8	75 x 125	0845 0266 ***	12	73	123	620	509	426	0845 0665 ***	12

C3/1-01

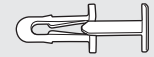

C3/1-01



C3/1-02

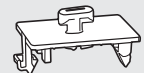

C3/1-02



C3/5-01



C3/6-01

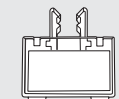

C3/6-01

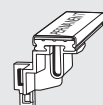

D4/6-01

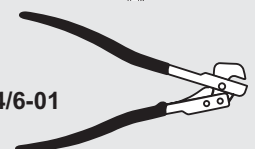



**GF-DIN-C-A12/8**

